



ARC-64

64" Dual Tank Rack Conveyor Dishmachine
Rated capacity of 338 20" x 20" racks per hours at 9.4 ft. per minute conveyor speed (approx. 8450 pcs. per hour).

- ARC-64ER - Electric heat, right-to-left operation
- ARC-64EL - Electric heat, left-to-right operation
- ARC-64SR - Steam heat, right-to-left operation
- ARC-64SL - Steam heat, left-to-right operation

STANDARD FEATURES

- **Seamless one-piece construction**
Uni-body fabricated from 16 ga. type 304 stainless steel.
- **25" Wash Tunnel**
Easily handles full-size sheet pans and stock pots up to 80 qt.
- **Front Mounted Controls**
Single on/off switch with auto-fill. Internal contact switches start pumps and drive when rack is inserted.
- **Easy Access 2 Hp Pumps**
Wash pumps mounted to machine front and accessed via lift-off panel. Stainless steel impeller assembly and motor shaft for long lasting durability and low maintenance.
- **Energy Saving Final Rinse Switch**
Final rinse water flows only when rack is passing.
- **Easy Clean Interchangeable Scrap Screens**
- **Single-point Electrical Connection**
- **Detergent Connection Provision**
- **Door Safety and Low Water Protection**

The Industry Leader in Efficiency

Adamation Rack Conveyors will wash more dishes, in less time, with lower operating costs and utility usage than any other machine on the market, as evidenced by NSF data.

ARC-64 Performance Data

- 338 Racks per hour at 9.4 ft./min. conveyor speed
- 0.57 gal/rack (3.21 gal/min.) water usage
- Reduced energy usage from less hot water consumed

OPTIONAL EQUIPMENT

**See spec sheets on individual options for complete details*

- **Vent Hood and Collar***
Reduces steam venting into dishroom to reduce cooling needs.
- **Side Loader***
Allows machine to be positioned in a corner to conserve space.
- **Power Unloader***
Increases productivity and reduces space requirements.
- **Booster Heaters***
Available in electric, steam or gas models.
- **Blower / Dryer***
Heated, forced-air rapid drying system.
- **Table Limit Switch**
Automatically stops machine when outfeed table is full.
- **Pressure Reducing Valve**
Adjusts incoming water line pressure to required spec.
- **Chemical Package (Low Temp)**
Machine preset at factory to utilize chemical sanitizer.
- **Prison Package**
Build to spec - consult factory for complete details.



Left-to-Right Operation

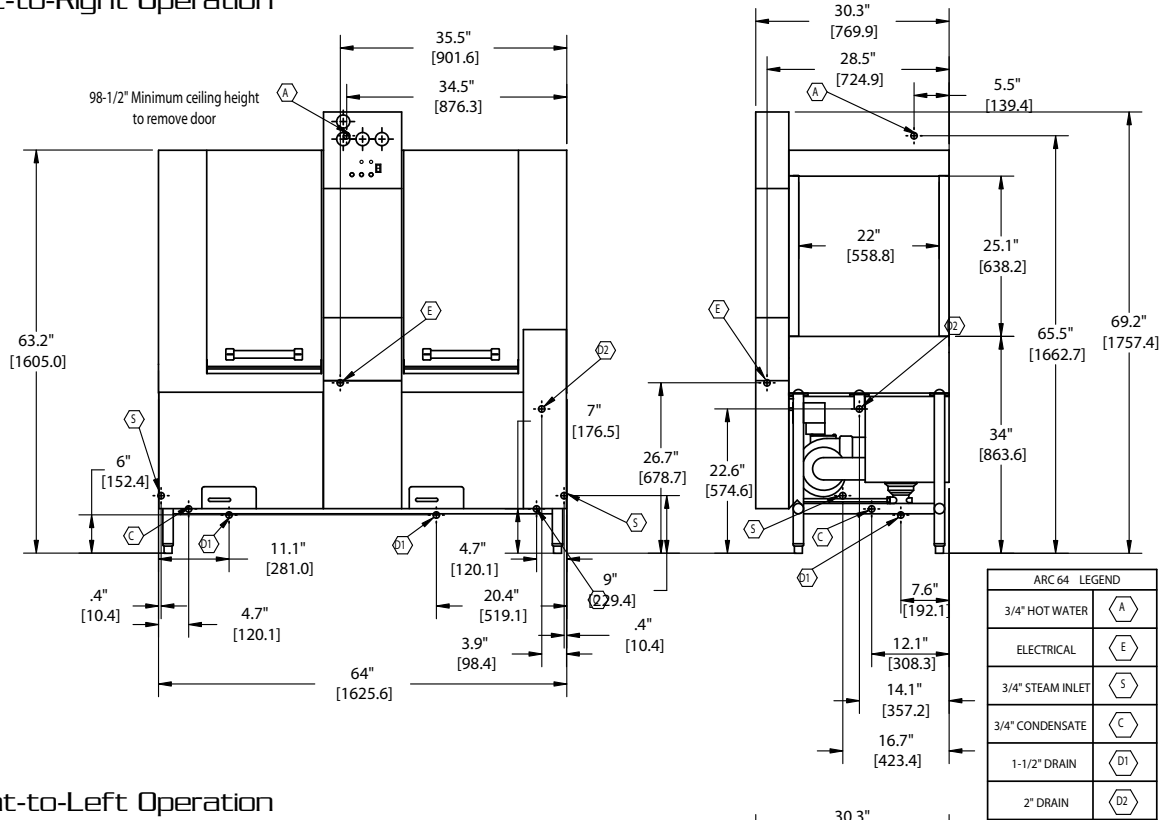

Right-to-Left Operation

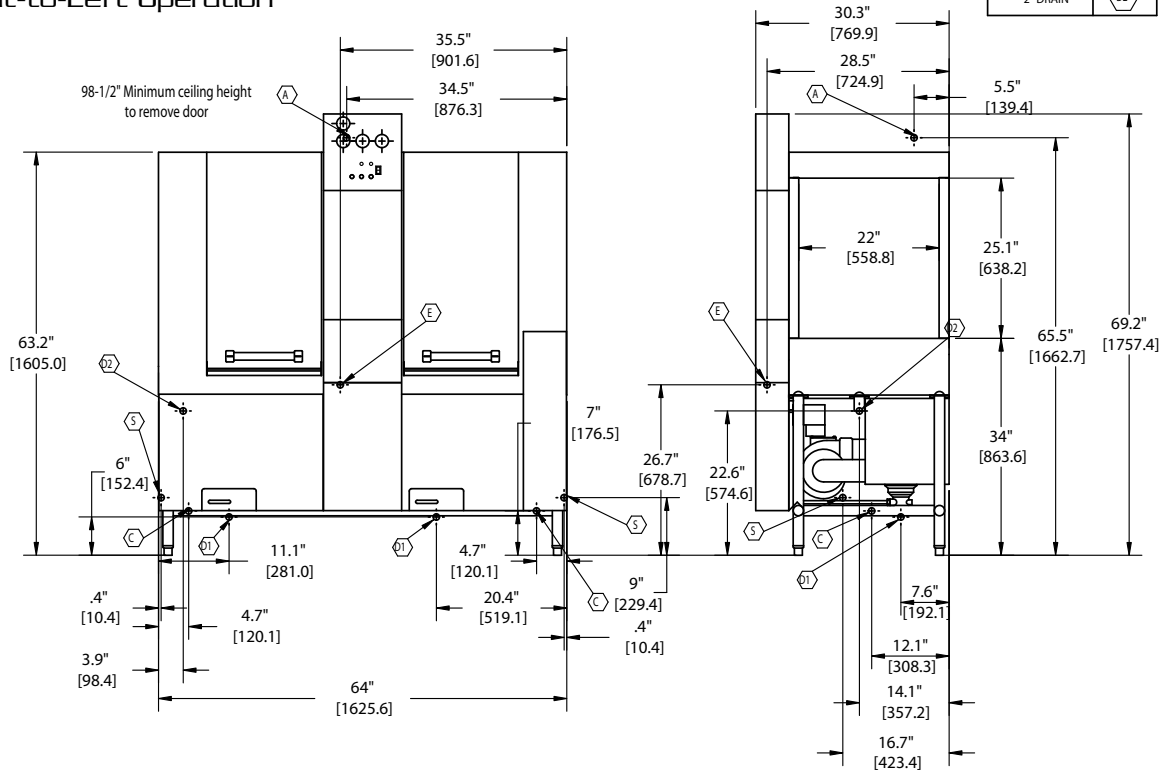

Specifications

Rated Capacity	Tank Capacity	Motors (HP / Qty.)	Pump Capacity	Rinse Water Usage (@20psi)	Exhaust (CFM)	Crate Size (L x W x H)
338 racks/hr	Prewash - N/A	Prewash - N/A	Prewash - N/A	193 gal./hr.	Load end - 400	72 x 38 x 75
9.4 ft./min.	Wash - 25 gal.	Wash - 2hp x 1	Wash - 300 gpm	0.57 gal./rack	Unload end - 700	Ship Weight
8450 pcs./hr.	Rinse - 25 gal.	Rinse - 2hp x 1	Rinse - 300 gpm	-	-	approx. 792 lbs.

Electrical Requirements

Current (V/Ph/Cyc)	Electric Heat	Steam Heat
208/3/60	95.6 amps	9.6 amps
440/3/60	45.7 amps	6.3 amps